

PSAV[®]

Meet**SAFE**

GUIDELINES

MeetSAFE

CONTENTS

Overview

Key Tentants

1. Meeting Design

- Design One - Single Venue, One Room
- Design Two - Single Venue, Multi Room
- Design Three - Multi Venue, Multi Room

2. Room Layout and Traffic Flow

3. Technology Considerations

4. Cleaning Guidelines

MeetSAFE

OVERVIEW

To help get the live event industry, event planners, and our teams back to work and begin the road to recovery following the COVID-19 pandemic, meeting safely will undoubtedly be a priority.

PSAV and our family of companies will be at the forefront in safe meeting practices related to the services provided by our industry leading brands. As shelter-in-place restrictions ease, physical distancing and enhanced cleaning procedures will remain an essential part of making people comfortable with meeting.

Risk and health are two key considerations for businesses and associations. An anticipated phase one recovery for our industry likely represents smaller meeting sizes following evolving government guidelines. With fewer people meeting and an enhanced cleaning procedures in place, the risk to attendees will be reduced.

How will meeting safely in the early stages of recovery look?

Working alongside venue partners, PSAV is designing a series of meeting formats, equipment packages, and recommendations that address how to reduce risk, increase confidence and promote health within the meeting space. Meeting design, room layout, traffic flow, technology considerations and enhanced cleaning procedures are at the heart of this offering with the goal to make the meetings and events industry strong and healthier than ever.

OUR FOCUS

The following document contains information outlining paths around how the event industry could re-open during the early phases of recovery. PSAV is committed to providing experiences that align with travel restrictions, physical distancing and best practices around health and safety.

MeetSAFE

KEY TENANTS

Meeting Design

- Smaller groups and consultation on creative use of full venue.
- Frequent use of multiple rooms and multiple venues.
- Expectation not all attendees will be physically present.

Room Layout & Traffic Flow

- Considerations around physical distancing will increase the space requirements and (likely) reduce room capacities.
- Signage becomes core deliverable.
- Chair/Table layouts will likely change.

Technology Considerations

- Larger room sizes impact core offering.
- Virtual/Hybrid component will be common.
- Enhancements to compliment new meeting designs including sound, aesthetics, single use items, etc.

Cleaning Requirements

- Transparency with customers on processes and commitments.
- Enhanced cleaning for high touch items.
- 'Set and Leave' for multiple uses.



MeetSAFE

1. MEETING DESIGN OPTIONS

As people return to in person meetings, smaller groups could potentially fall into three meeting designs. These designs will incorporate physical distancing measures that align with evolving governmental and local venue guidelines, showcase technology solutions allowing presenters and attendees to connect and apply measures to keep high touch event technology equipment clean.

MeetSAFE Design 1

One Room

Ideal for a smaller group meeting in a single room at one venue. With physical distancing in mind, screen placement, sound reinforcement, and the ability to connect with others not able to physically attend will be key considerations.

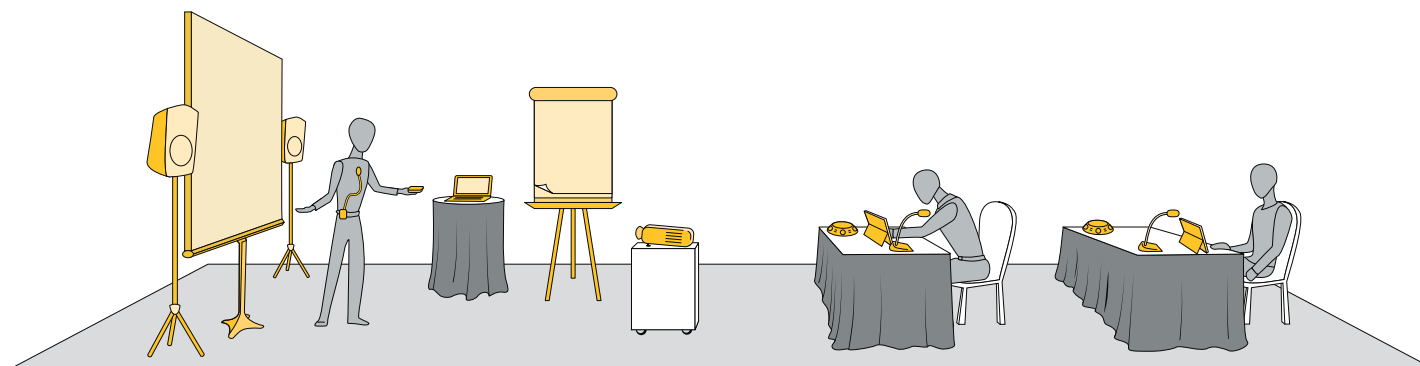

MeetSAFE Design 2

Multi-room, Broadcast Communication

Accommodates large groups that may need to be split into multiple rooms at the same venue. Building off the technology in design one, broadcasting to multiple rooms will be critical and the use of digital tools that support two-way collaboration will add to the experience.

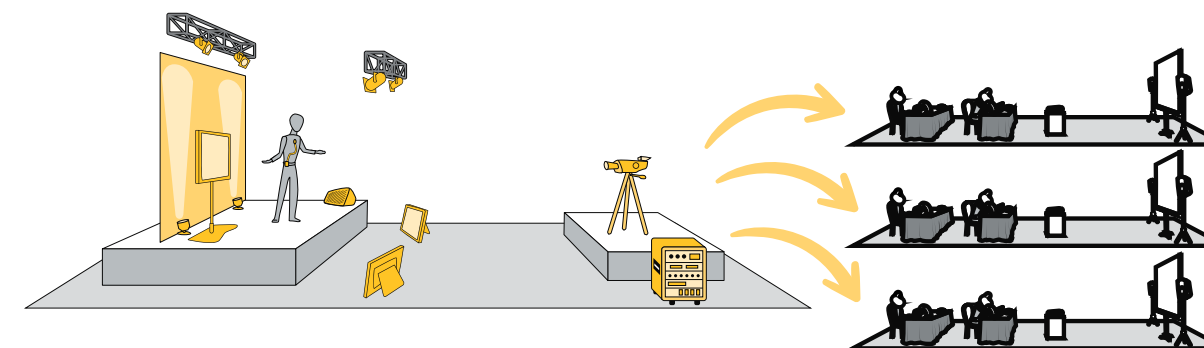

MeetSAFE Design 3

Multi-room/Multi-venue, Networked Communication

For events that bring attendees from multiple venues and potentially multiple rooms together. The ability to have several presenters delivering messages to multiple audiences simultaneously will require a suite of technology solutions to make the experience feel as if everyone is meeting together as one.

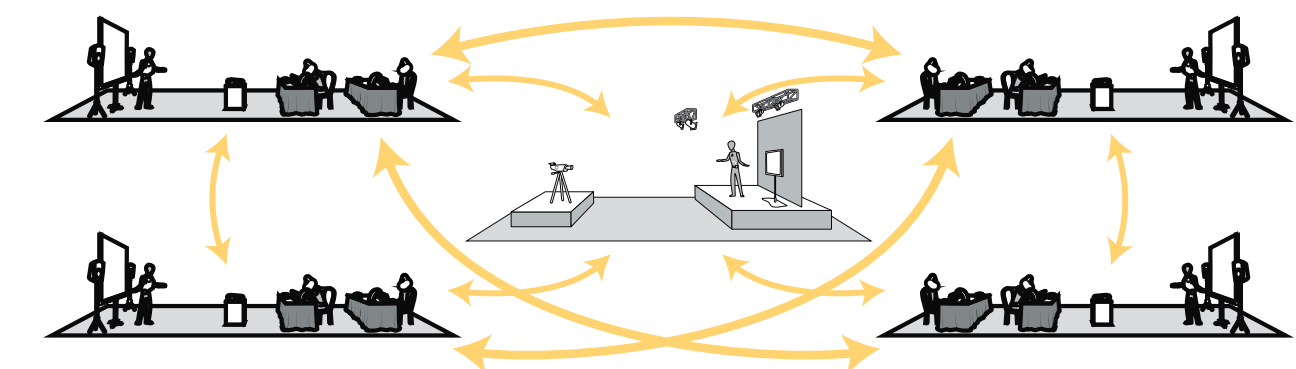

*Hybrid: All three meeting designs can incorporate a virtual stream for attendees that are not able to make the in-person meeting.

MeetSAFE

MeetSAFE Design 1

One Room

Design One represents an event taking place that requires just one meeting room at a single venue. This type of meeting has been at the core of our industry for years and will serve the needs of smaller groups with the option to add virtual components.

Examples of this type of meeting are local groups that are not traveling but still want the benefit of meeting in person; or groups coming in from other regions who want to adhere to current guidelines defining the size of group gatherings.

Design One will outline a meeting where participants can once again connect in person and can be scaled to size in accordance with evolving governmental and local venue guidelines. If anyone cannot attend in person for any reason, web-conferencing and recording technologies can be utilized to make sure everyone can **MeetSAFE**.

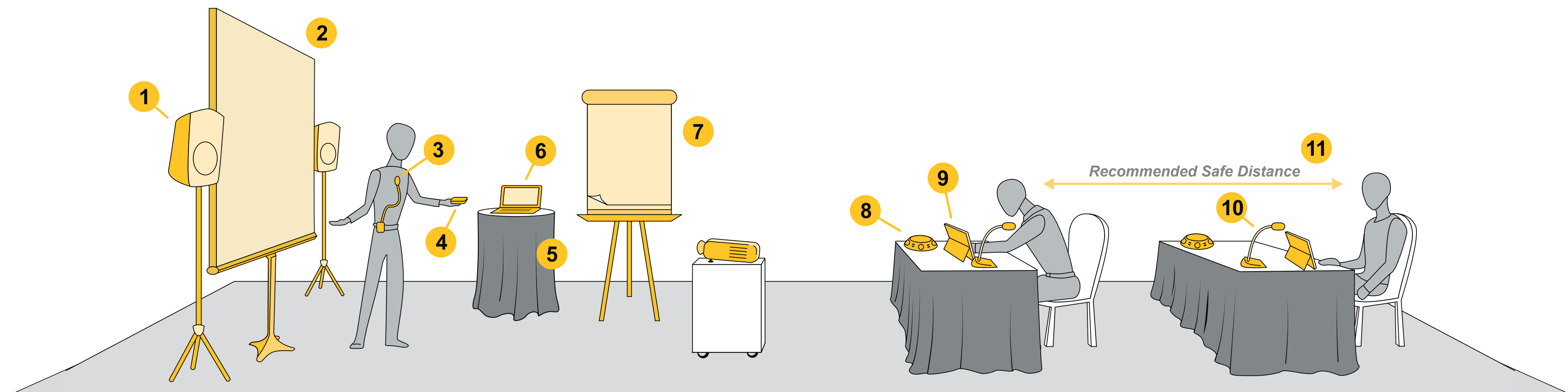

MeetSAFE

MeetSAFE Design 2

Multi-room, Broadcast Communication

Design Two represents an event taking place that requires multiple rooms at a single venue. This type of meeting accommodates large groups split into multiple rooms. Building off the technology in Design One, connection between rooms will be critical and the use of digital tools for collaboration can add to the experience.

This meeting design ensures that larger groups separated into multiple rooms still have a unified experience.

A Design Two meeting also allows participants to connect in person and can be scaled to size in accordance with evolving governmental and local venue guidelines. If anyone cannot attend in person for any reason, web-conferencing and recording technologies can be utilized to make sure everyone can **MeetSAFE**.

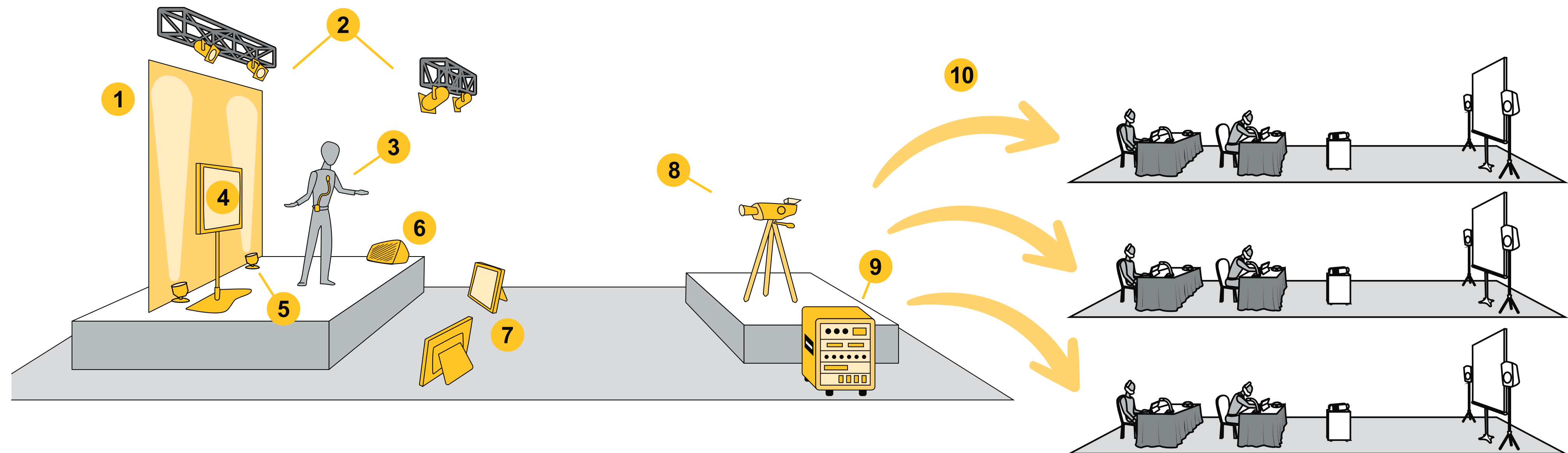

MeetSAFE

MeetSAFE Design 3

Multi-room/Multi-venue, Networked Communication

Design Three represents an event taking place that allows for multiple rooms at multiple venues. The ability to have several presenters delivering messages to multiple audiences simultaneously will require a suite of technology solutions to make the experience feel as if everyone is meeting together as one.

This type of meeting accommodates groups of all sizes split into multiple rooms at multiple venues and still facilitates a unified experience. Building off the technology in Design One and Two, connection between rooms will be critical and the use of additional digital tools for collaboration will enhance the experience.

A Design Three meeting also allows participants to connect in person in regional pods and can be scaled to size in accordance with evolving governmental and local venue guidelines. Should disruptions occur prohibiting a portion of the group's in-person participation, web-conferencing and recording technologies can be utilized to make sure everyone can **MEETSafe**.

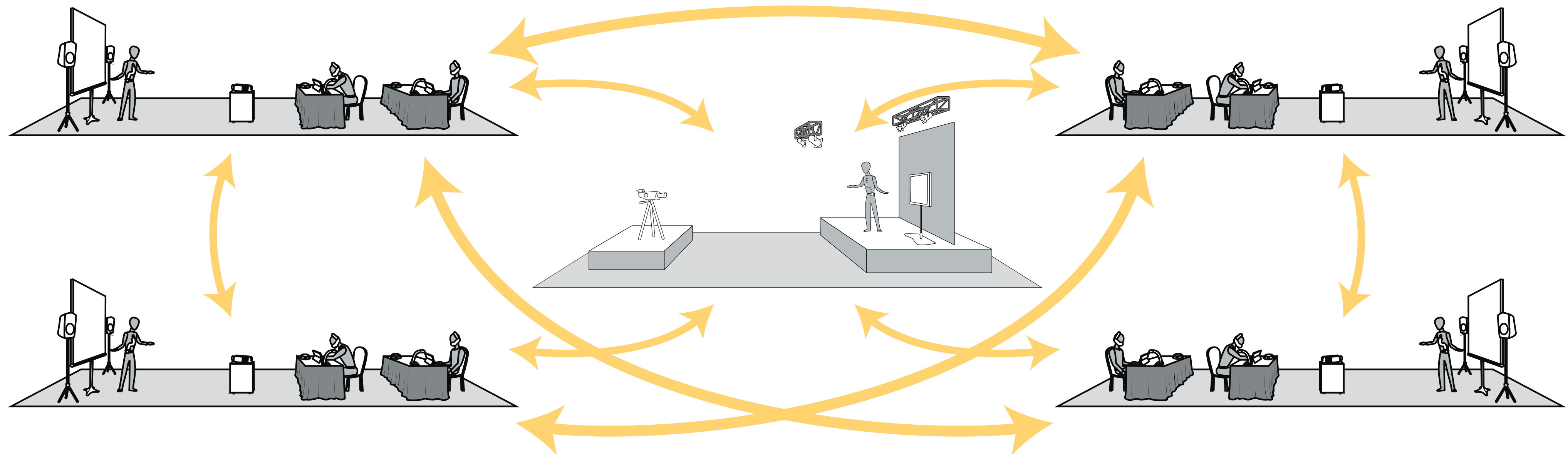

MeetSAFE

2. ROOM LAYOUT & TRAFFIC CONTROL

PSAV along with our venue partners will work with customers to design layouts with your safety and preference in mind.

To assist with the design process, PSAV has created a few examples illustrating how meeting rooms might look as you return to having in person events.

There is little doubt that during the earliest phases of recovery, physical distancing will impact the room requirements.

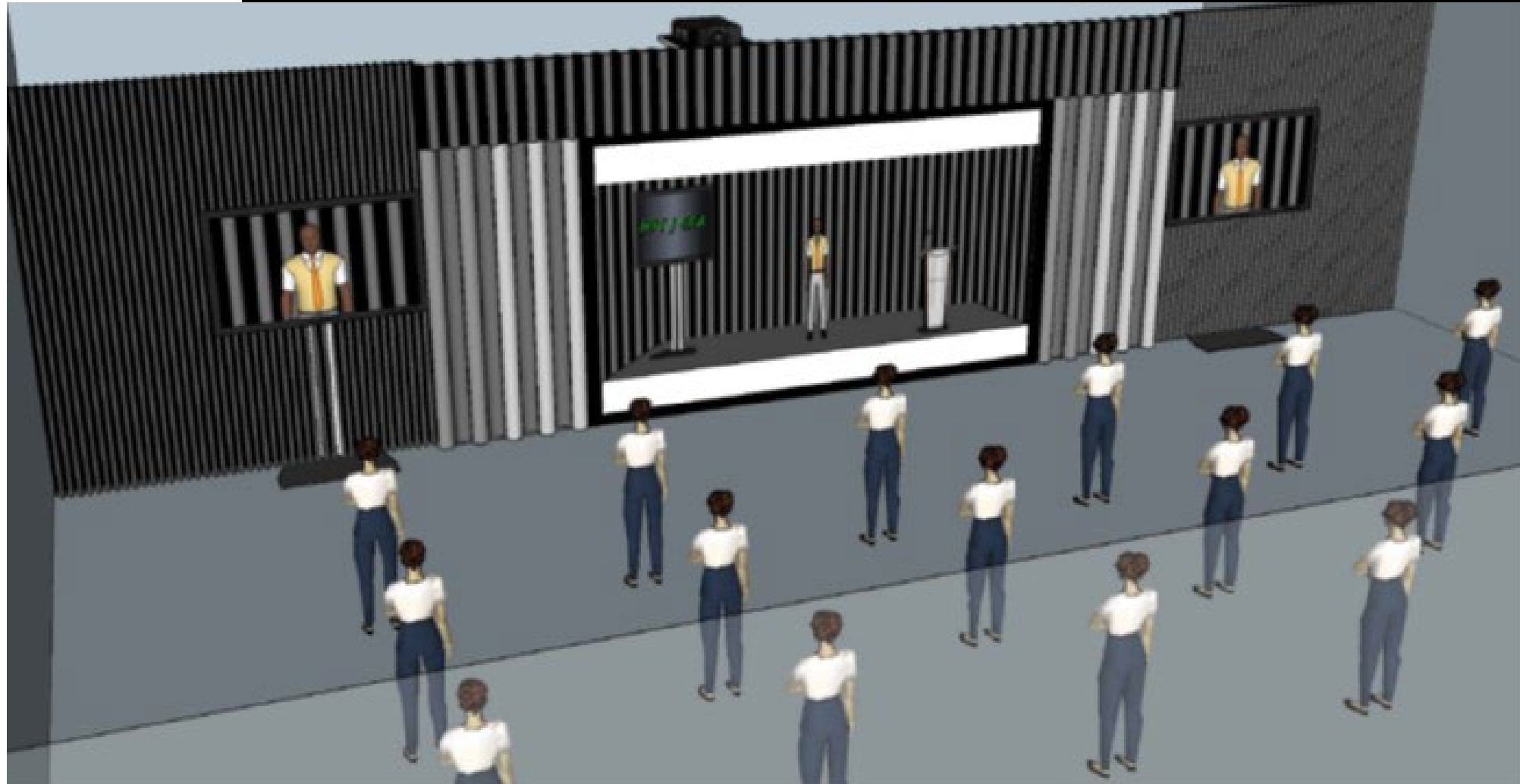

MeetSAFE

Rendering Option - 25 ppl Classroom

Physical Distancing Considerations:

- Attendee Spacing
- Ingress/Egress
- Aisle(s)
- Presenter Placement



MeetSAFE

Floor Plan Option - 10 ppl U-Shape

Traditional U-Shape Diagram - 24ppl
37' x 42' : 1554 sqft

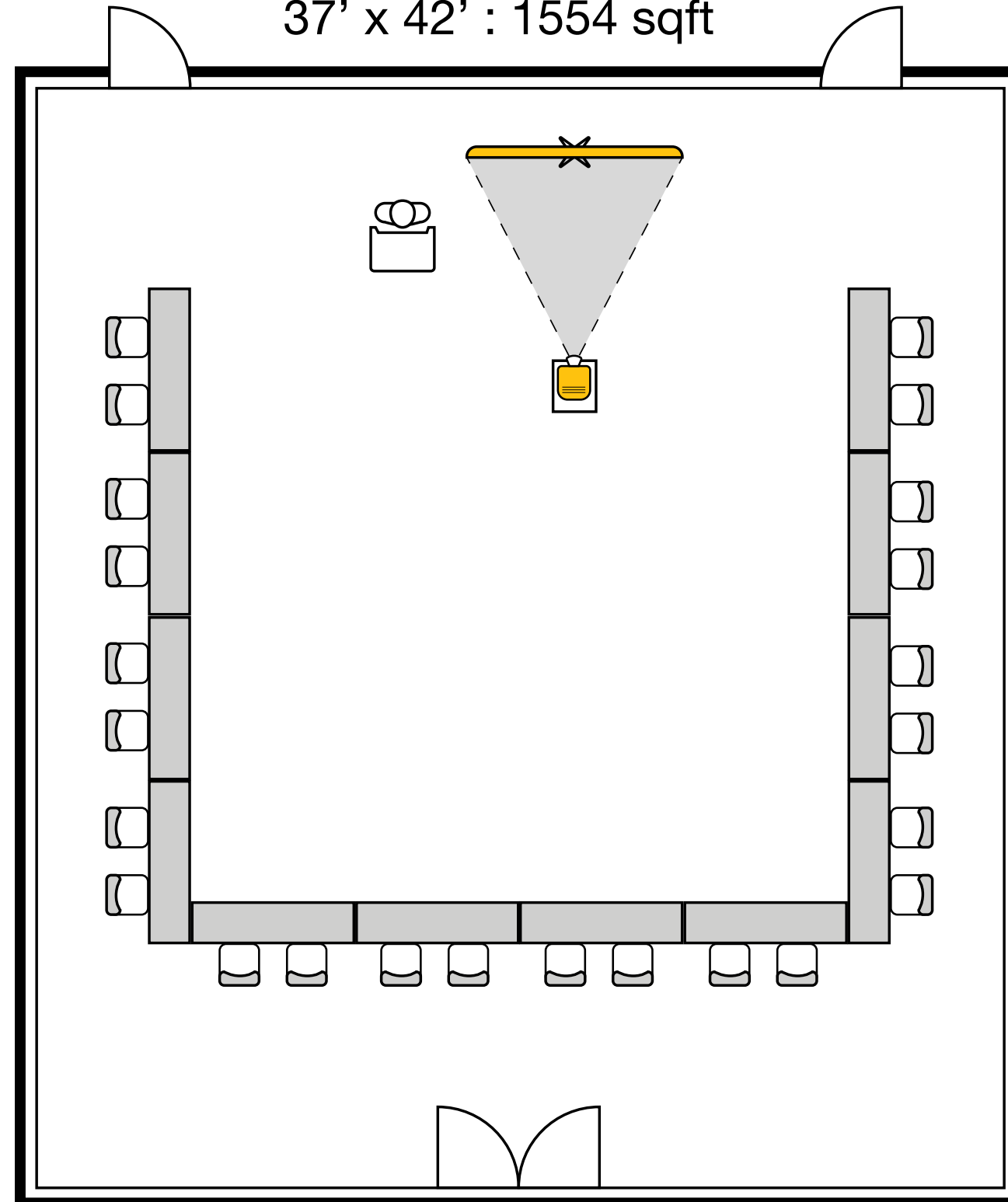

NEW

Modified U-Shape Diagram - 10ppl
37' x 42' : 1554 sqft

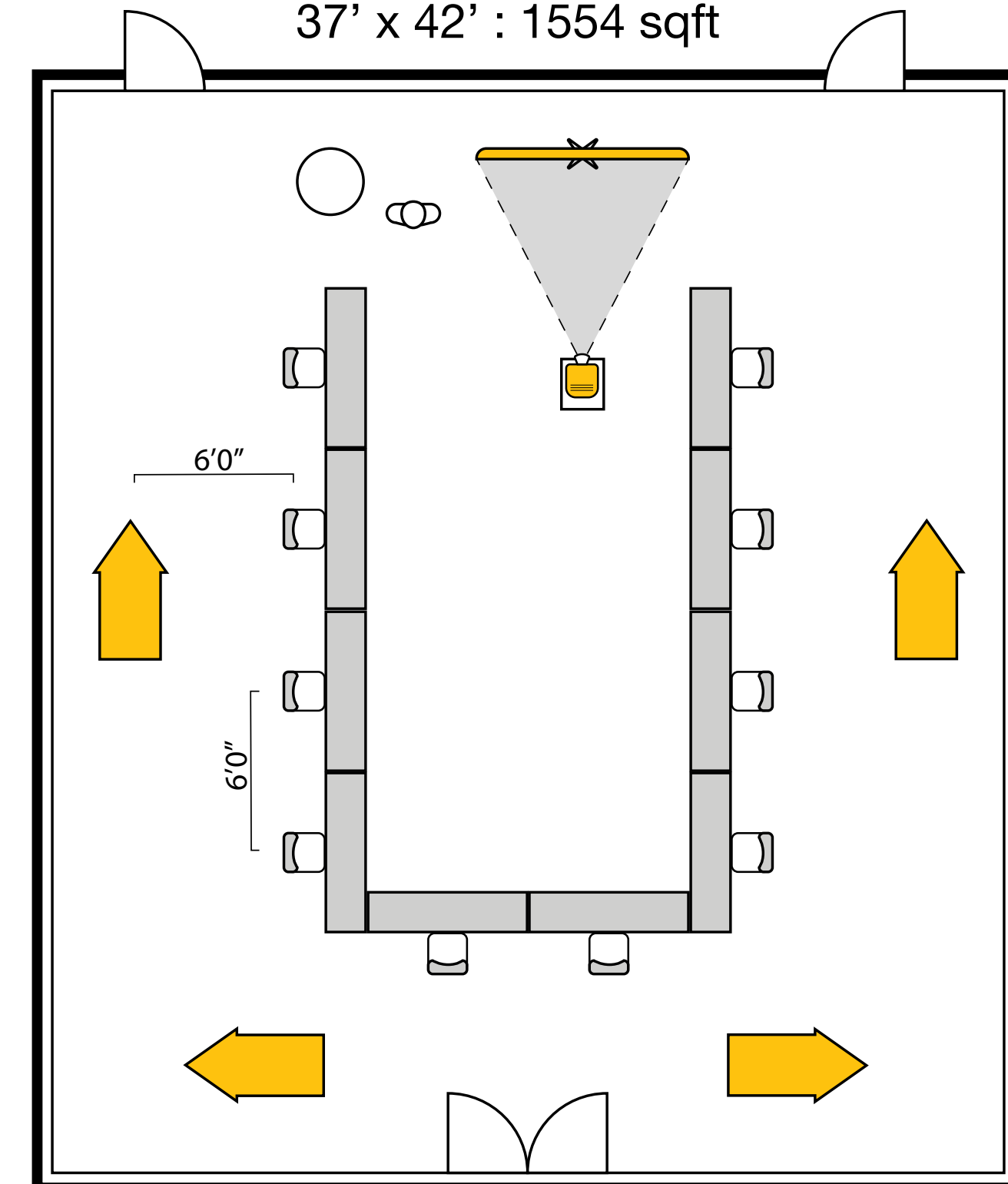

- Increased distance between each attendee. This is designed to help maintain limited contact within the meeting environment.
- Intentional directionally based traffic flow within the room as indicated by decals that are on the floor.

MeetSAFE

Floor Plan Option - 10 ppl Classroom

Traditional Classroom Diagram - 40ppl
50' x 29' : 1450 sqft

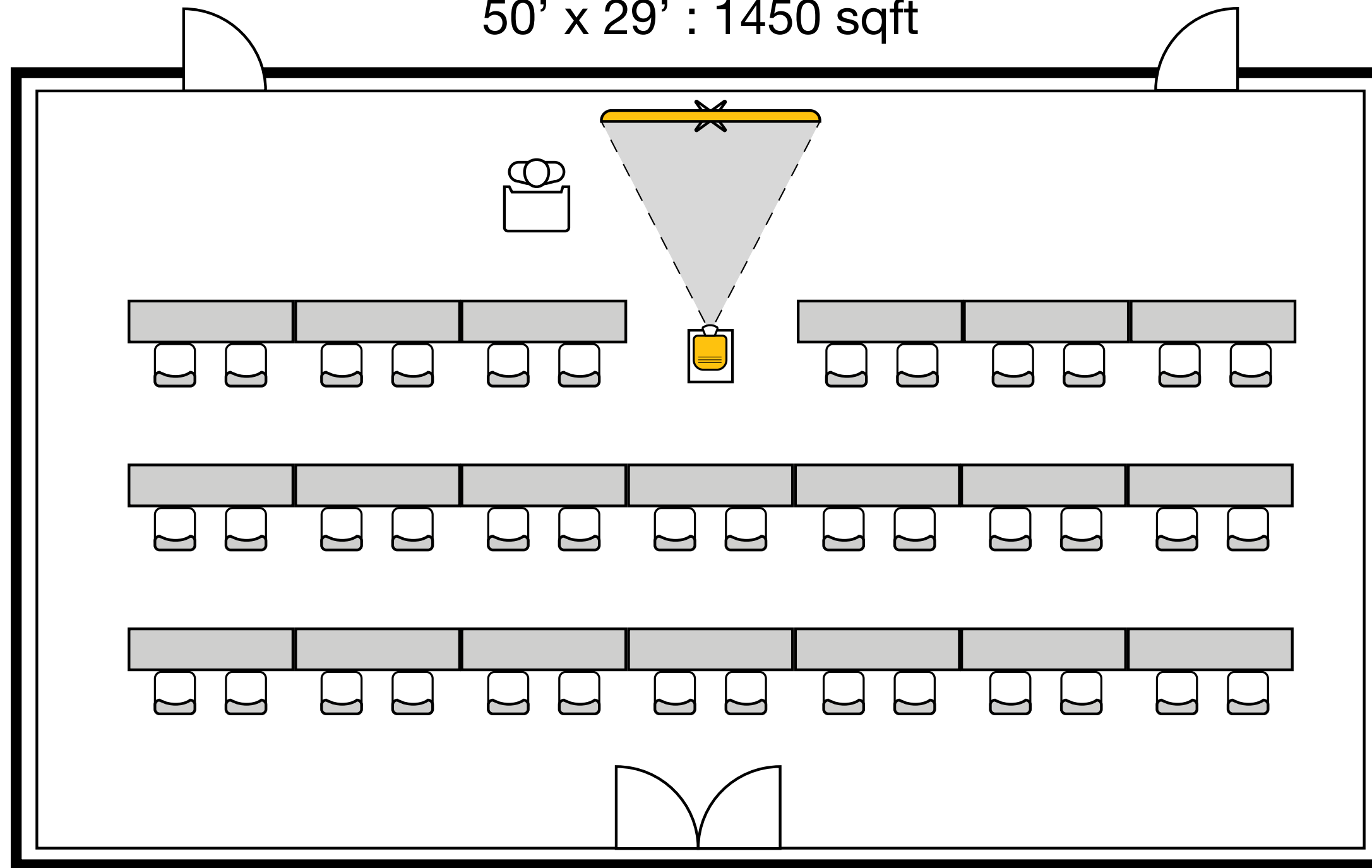

NEW

Modified Classroom Diagram - 10ppl
50' x 29' : 1450 sqft

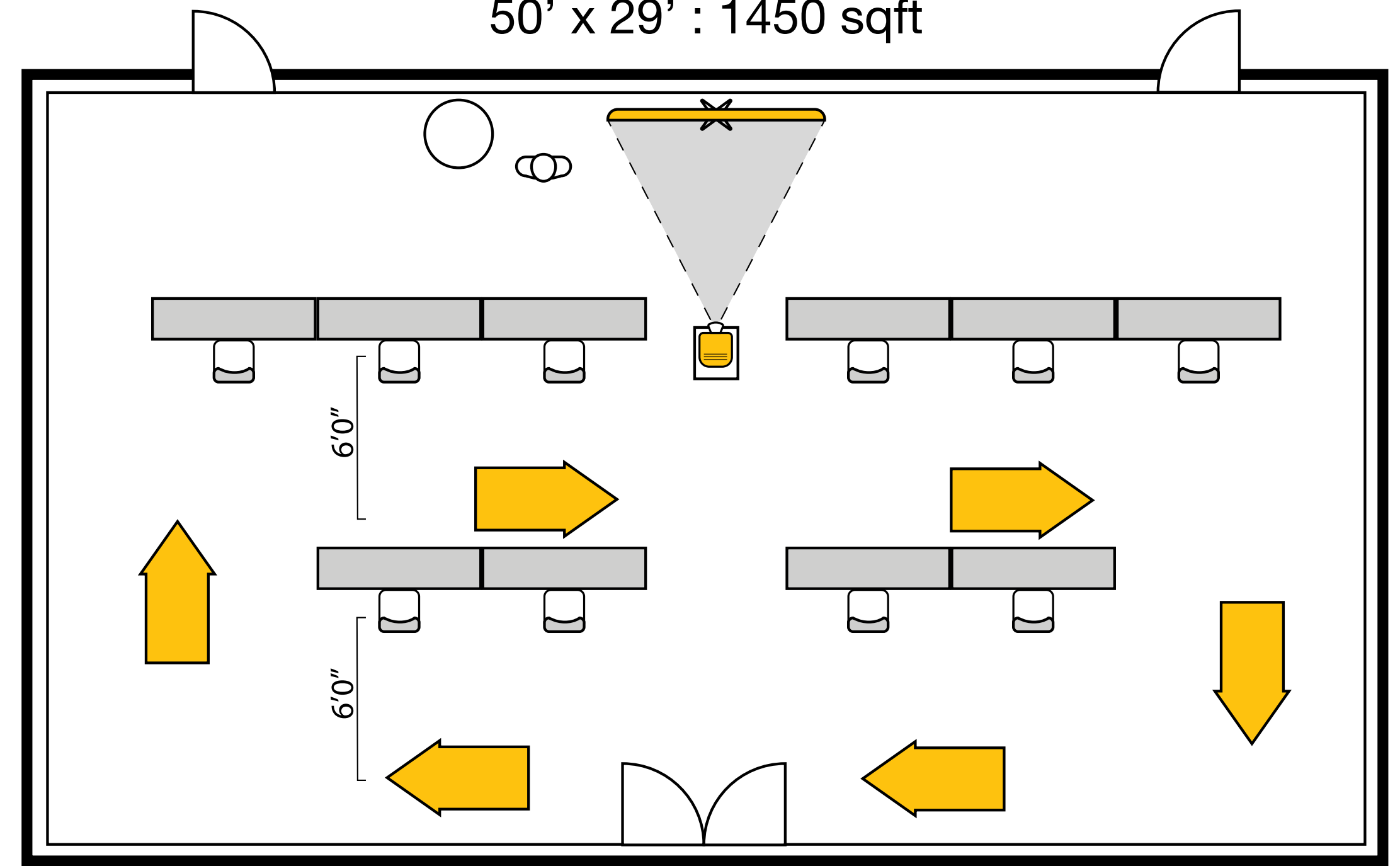

MeetSAFE

Floor Plan Option - 25 ppl Classroom

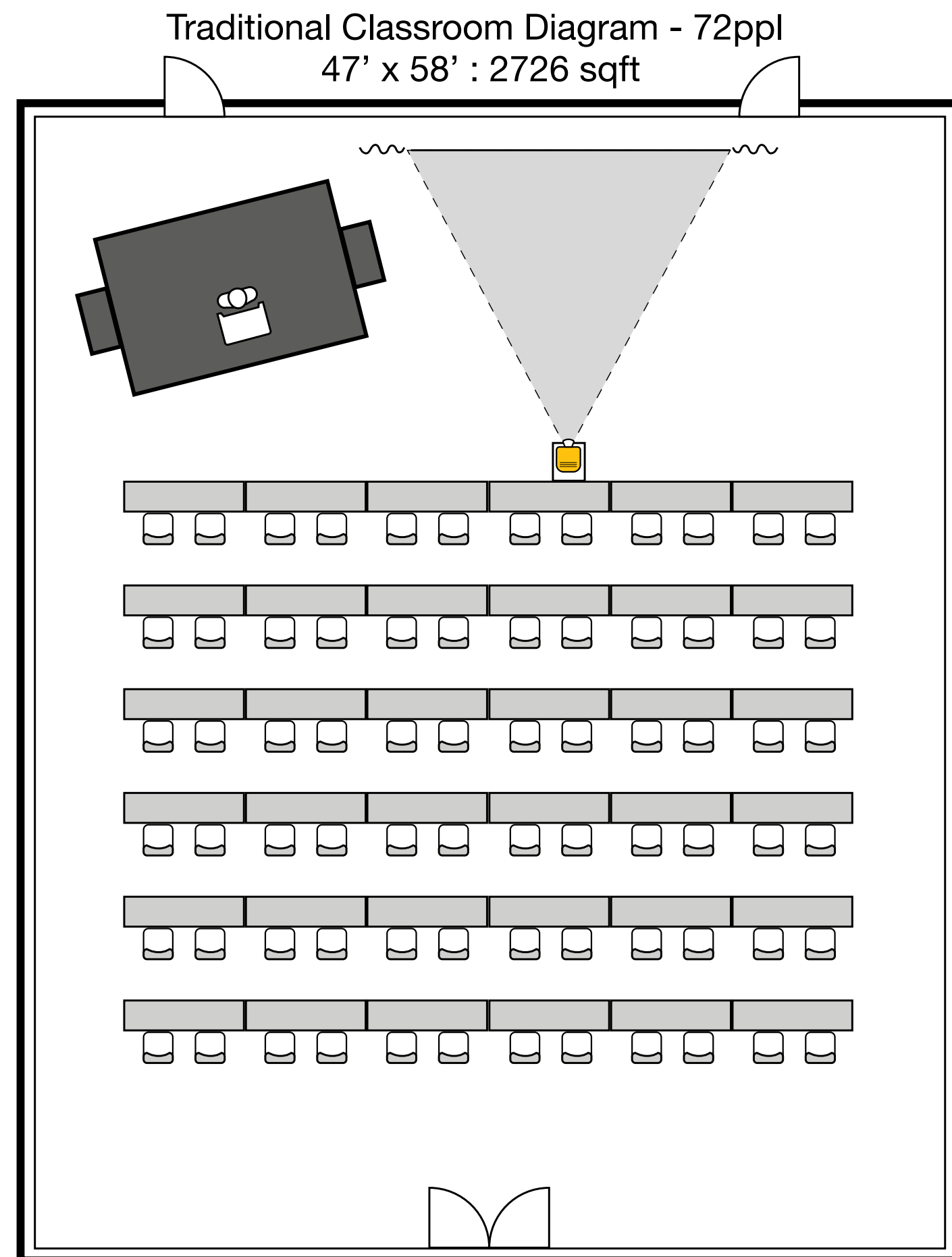

NEW

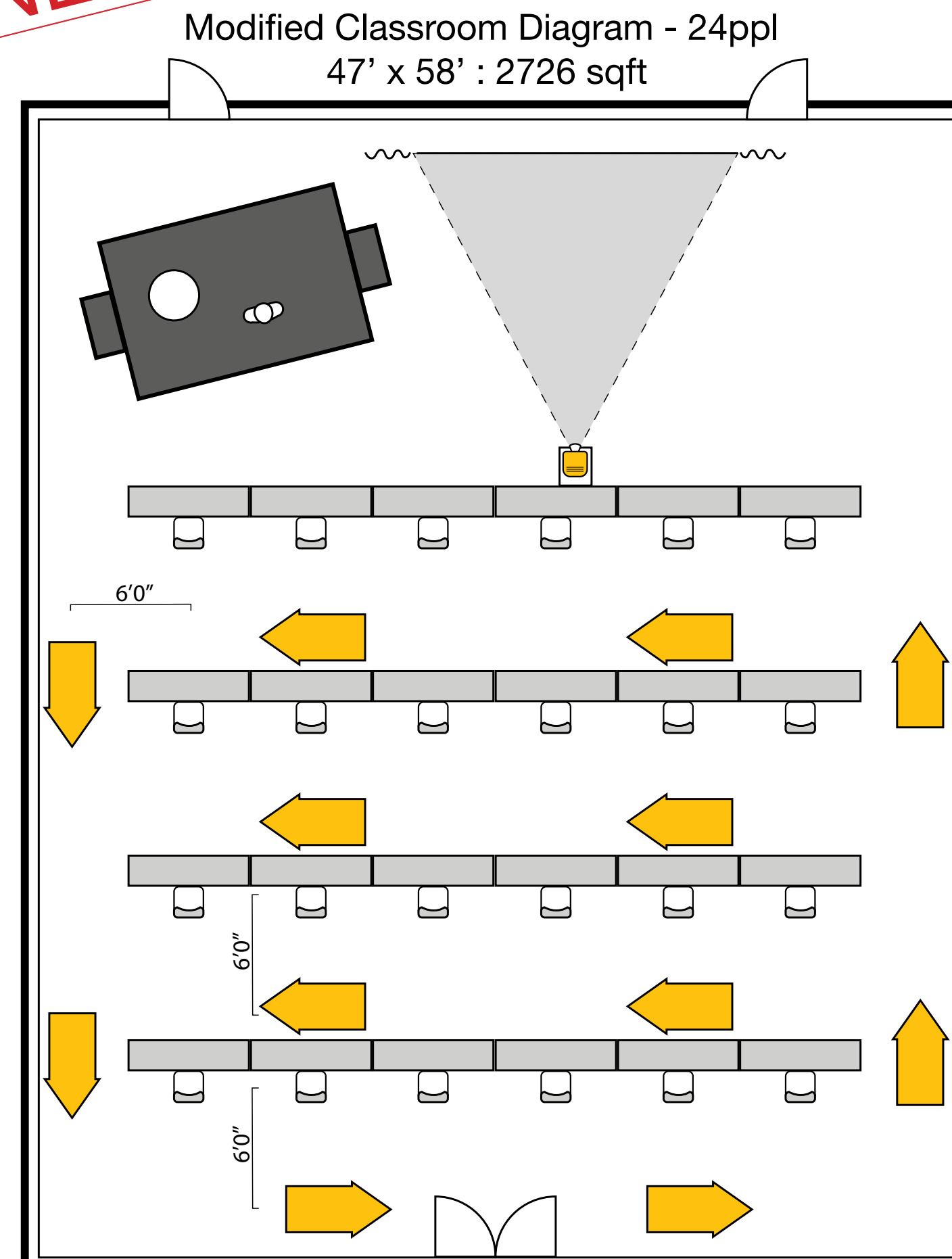

MeetSAFE

Floor Plan Option - 25 ppl Single Chair

Traditional Rounds Diagram - 110ppl
51' x 53' : 2703 sqft

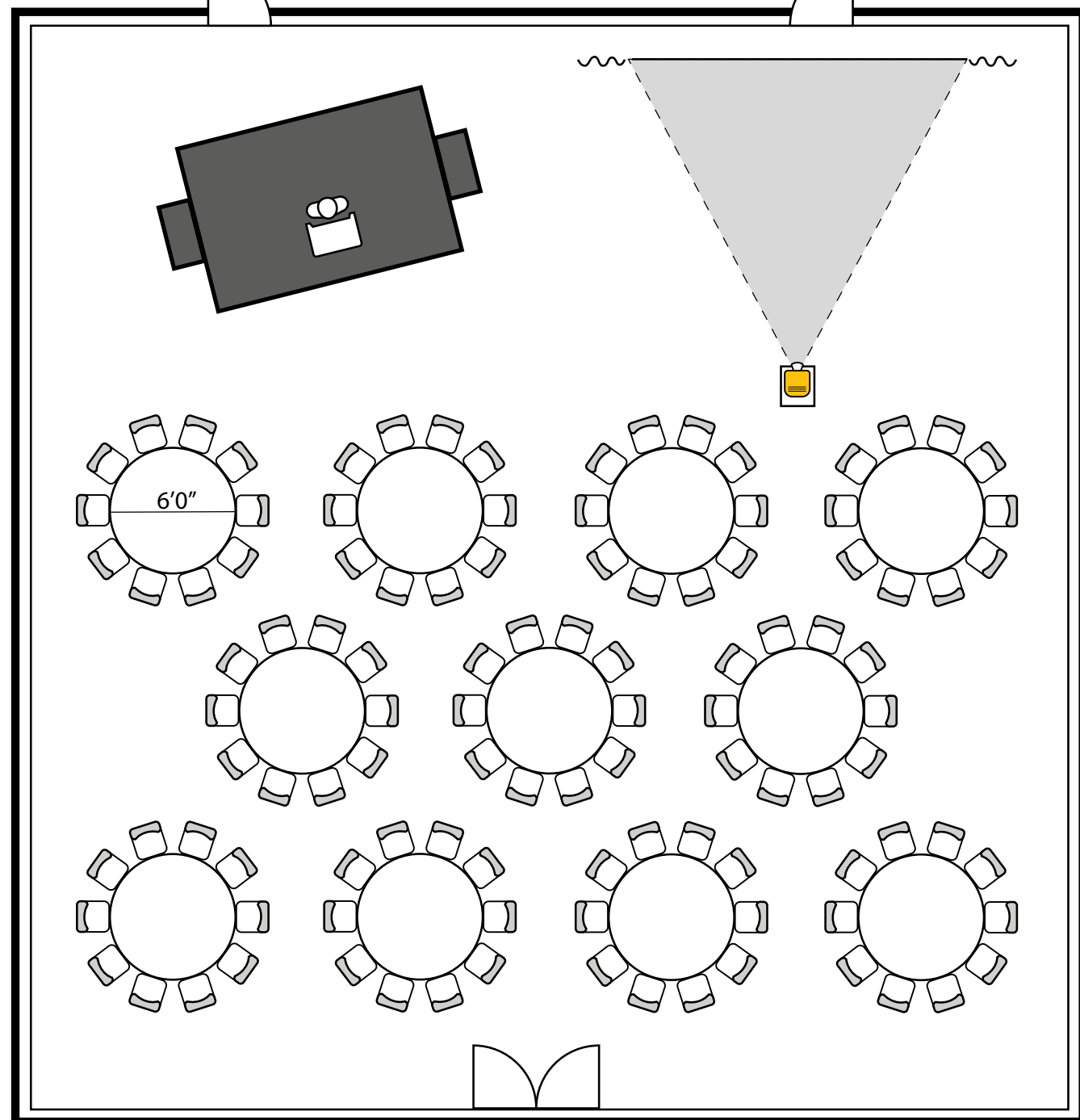

NEW

Modified Dual Rounds Diagram - 24ppl
51' x 53' : 2703 sqft

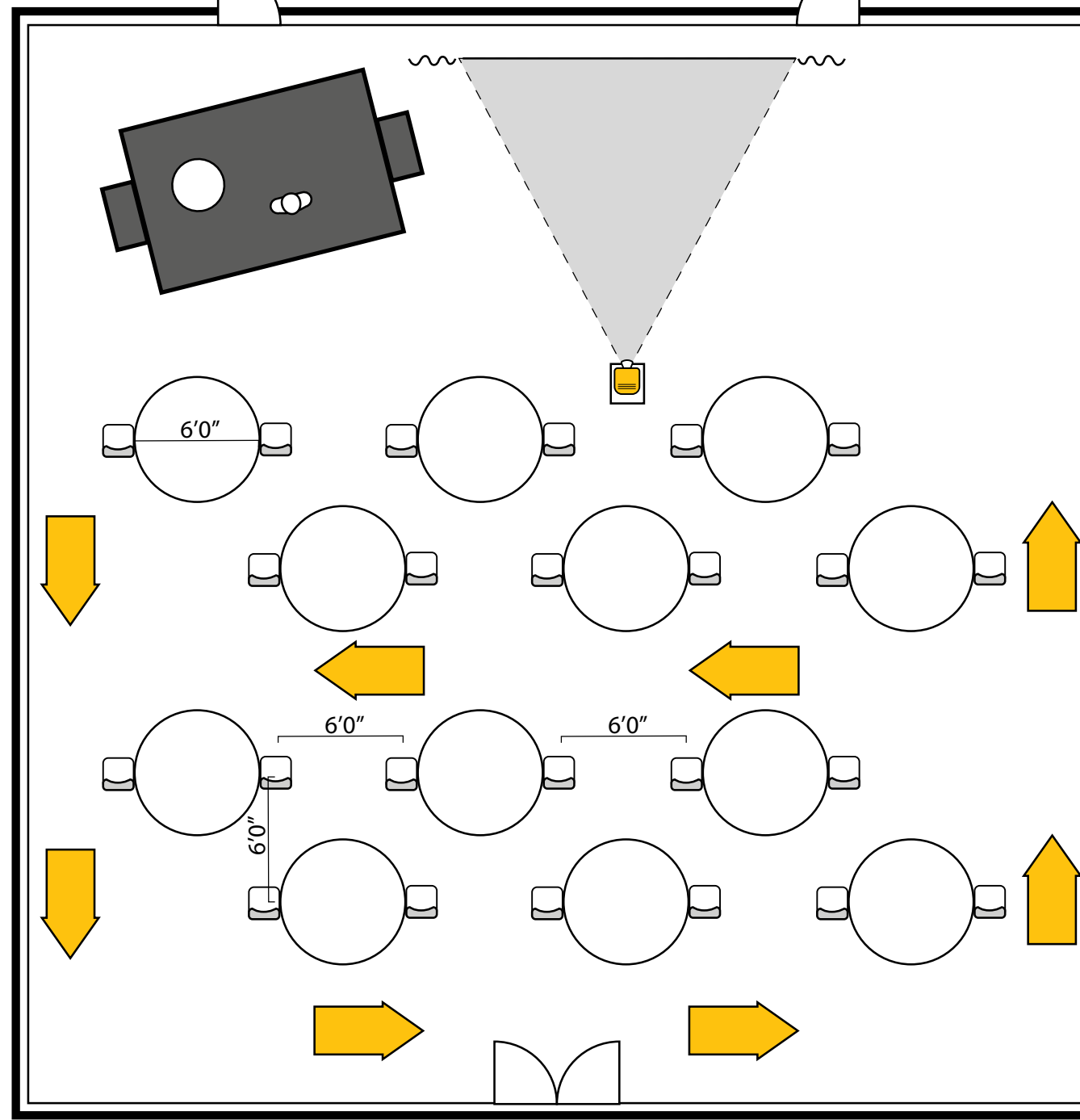

NEW

Modified Single Rounds Diagram - 24ppl
51' x 53' : 2703 sqft

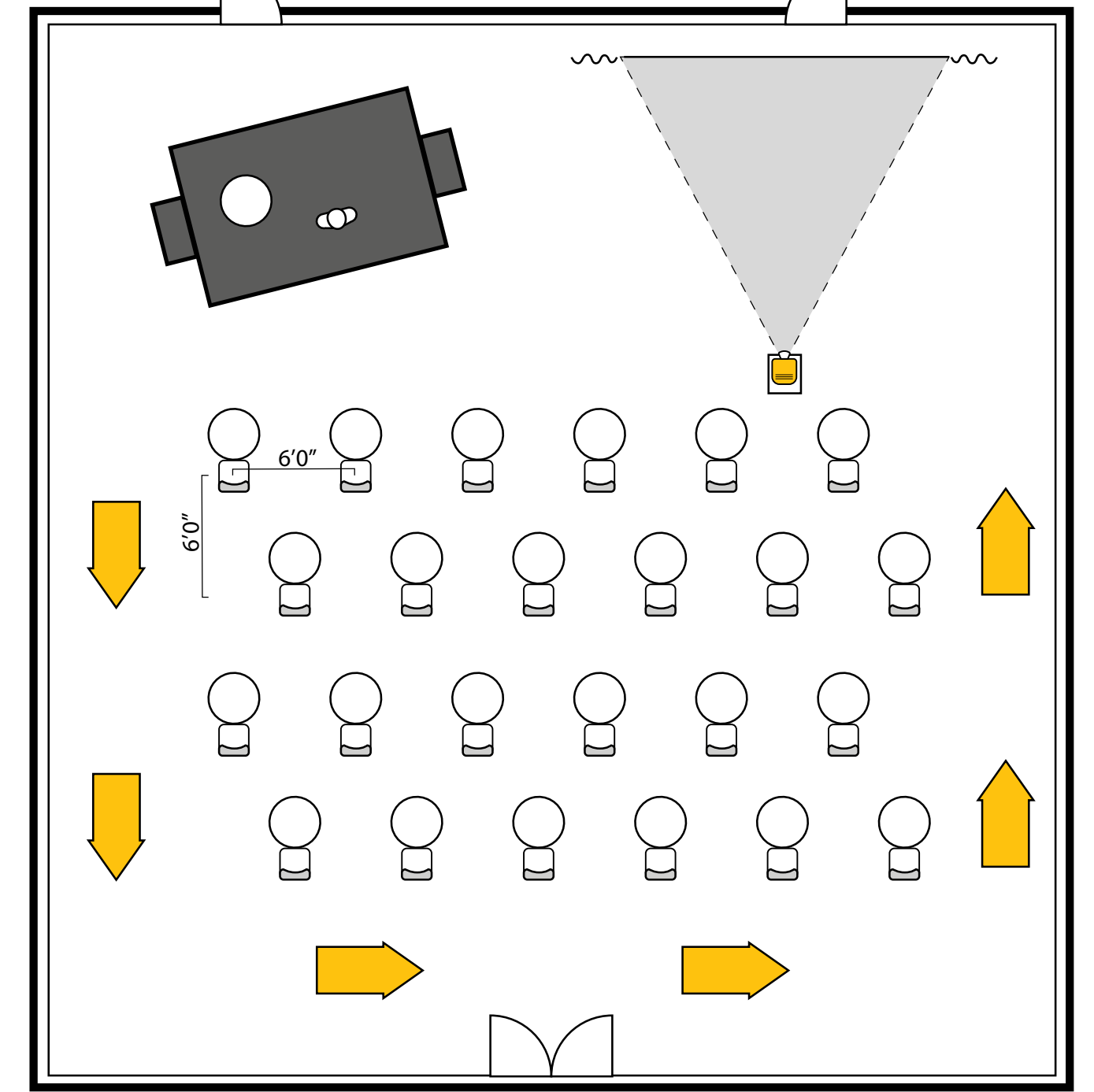

MeetSAFE

3. TECHNOLOGY CONSIDERATIONS

This illustration highlights technologies that can help support these meeting designs. Beyond traditional items like projectors and screens, items to support sound reinforcement, recording, web-conferencing and digital tools for polling and Q/A should be considered.

- Drive up Collaboration
- Engage with your Audience
- Welcome in Remote Participants
- Capture your Event and Share

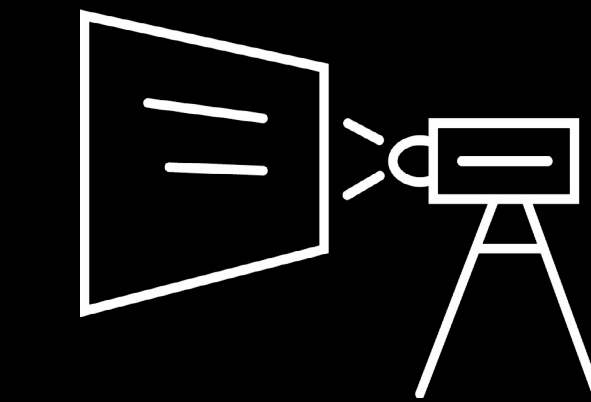

Traditional Projector and Screen

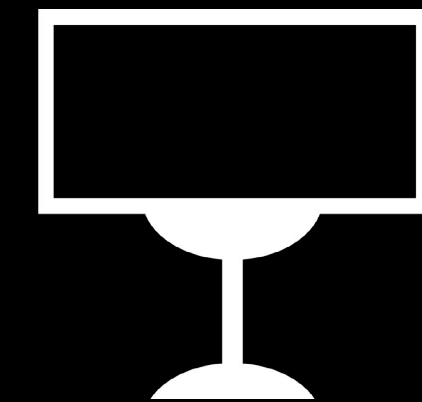

Delay Monitors for those in the back of the room

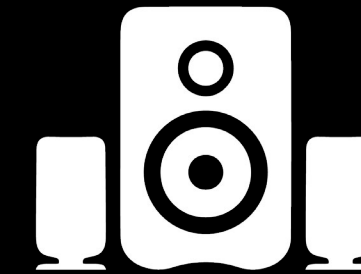

Add sound reinforcement when appropriate



Digital Q/A or Polling Devices to assist with physical distancing measures.

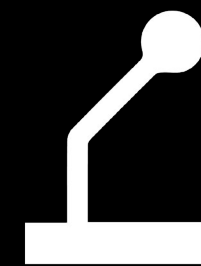

Push to talk MICs to assist with everyone being heard



Reduce touch points by using wireless presenter tools like Click Share

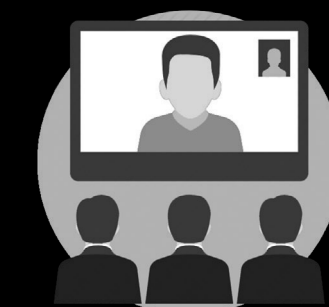

Leverage web-conferencing to bring in remote participants



Record your event for those not able to attend



MEETSafe Design 1

One Room

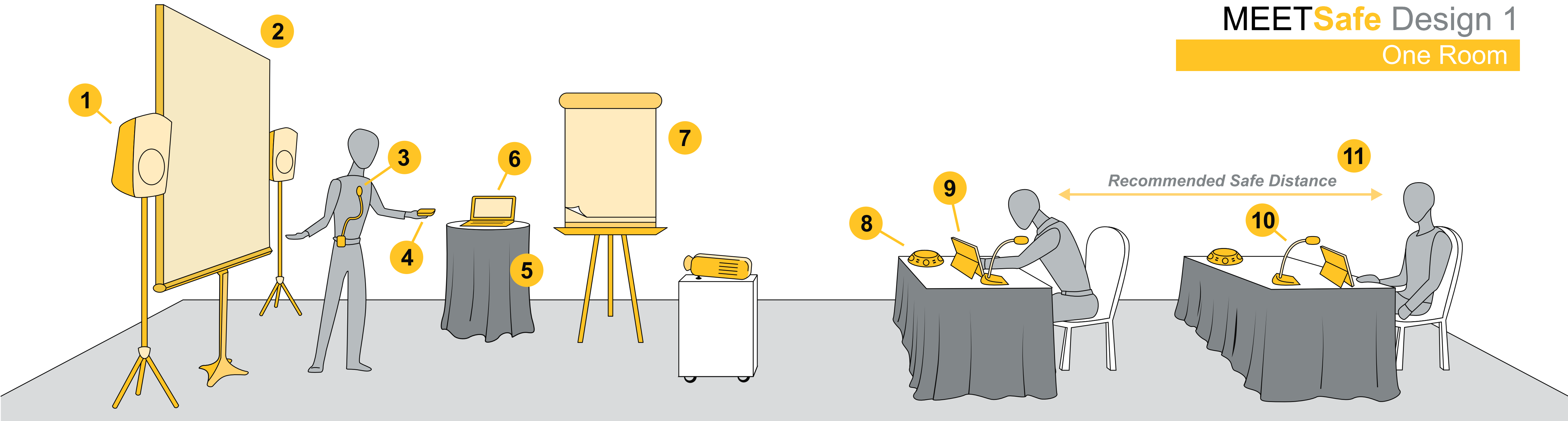

- | | |
|--------------|--|
| Enhancements | <ul style="list-style-type: none"> 01. Powered speakersAudio reinforcement is recommended for additional square footage 02. Screen and projector (or monitor) Larger room sizes and audience distances can be mitigated by larger screens and brighter projectors 03. Wireless microphones.....Highest standard of cleaning on mics, one per presenter recommended 04. Wireless presentation advancer.....As a common touch item, revolving advancers are cleaned between presenters, one per presenter recommended 05. Highboy.....As an alternative to high contact lecterns, use of highboys to support presentation materials discourages leaning 06. Presentation laptop While most presenters will travel with their own, a laptop can be added and preloaded with all presentations to minimize touching cables 07. Flipchart (or collaboration board).....Whether using a flipchart or digital collaboration board, a single, designated user is advised for each instance 08. Power center..... Attendee power option are recommended at each station to allow people to remain at their individual desks 09. Smart tablet..... For collaborative experiences or connectivity between meeting rooms, each attendee may need a smart tablet 10. Q&A or push-to-talk microphonesIn a larger room, push-to-talk microphones will be preferred to facilitate conversation, and one mic per attendee is recommended 11. Responsible physical distance Desks/seating can be set to accomodate physical distancing as determined by local regulations and meeting planner oversight |
|--------------|--|

ADDITIONAL ENHANCEMENTS

- | | | |
|--|--|--|
| <ul style="list-style-type: none"> • Engage Meeting Package • Comfortable seating • Scenic accents • Signage for wayfinder and traffic | <ul style="list-style-type: none"> • Digital signage • Recording • Transcription services • Webcast/conference systems | <ul style="list-style-type: none"> • Presenter foldback speaker • Clickshare |
|--|--|--|

EVENT CREW

- | |
|---|
| <ul style="list-style-type: none"> • Set/Strike team • Cleaning team • Floating or in-room technician • Operators as-needed |
|---|

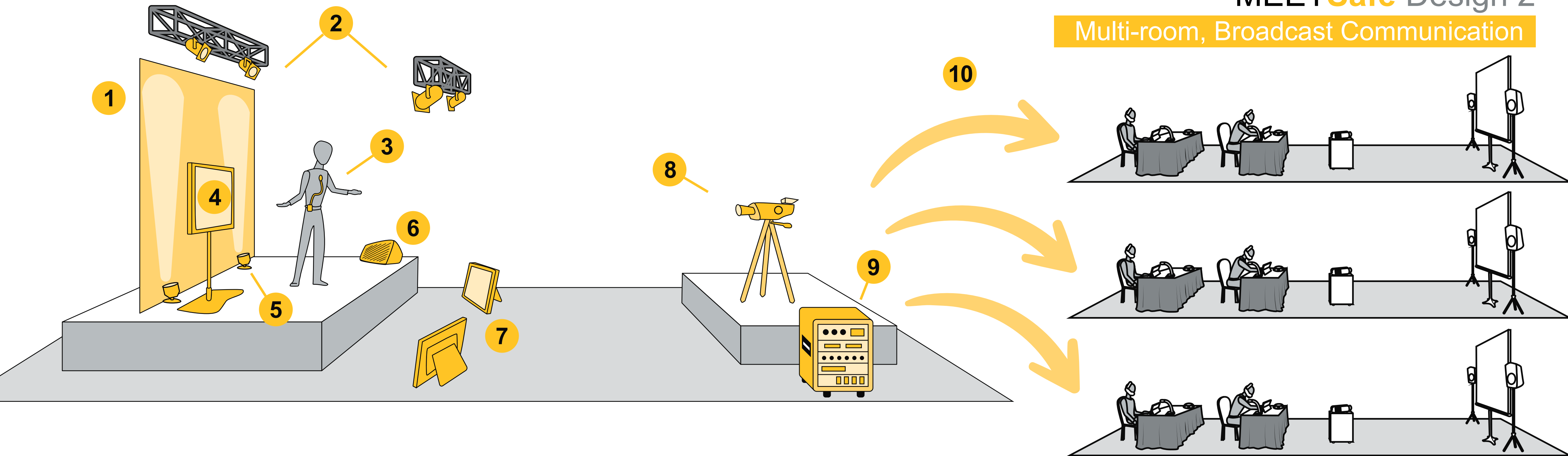

In addition to DESIGN 1:

01. Scenic Used as presentation backdrop
02. Stage lighting Stage lighting will be recommended for optimal camera exposure
03. Wireless microphone Highest standard of cleaning on mics, one per presenter recommended
04. Presentation monitor Recommended to create more natural presentation during wide shots
05. Accent lighting Needed to light scenic
06. Foldback audio Allows presenter to hear program and engage in Q&A with Design 1 rooms
07. Confidence monitor Confidence view for the presenter when facing forward
08. Camera Required to capture presentation for webcast
09. Webcasting Hardware Used for connecting presentation studio to breakout rooms
10. Dedicated wired Internet (VLAN) Used for connecting presentation studio to breakout rooms
11. Headphones with in-line microphone To avoid open speakers/microphones in collaborative situations, headphone/mic combos will help control the noise

ENHANCEMENTS

- Engage Meeting Package
- Comfortable seating
- Large format scenic such as Backdrop Pro
- Signage for wayfinder and traffic
- Digital signage
- Recording
- Transcription services
- Webcast microsite
- Chime
- Content One content management system

EVENT CREW

- Set/Strike team
- Cleaning team
- Operating team
- Webcasting team
- Project Manager
- Stage Manager
- Producer

Multi-room/Multi-venue, Networked Communication

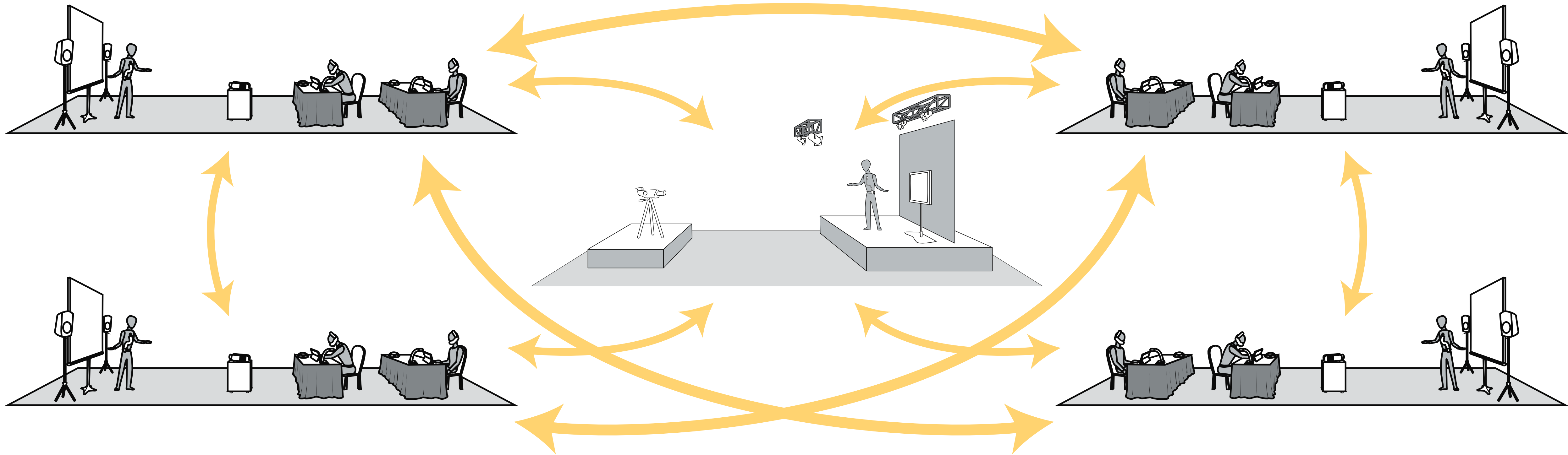

In addition to DESIGN 2 and 1:

- 01. Chime Chime and Chime Live will serve as one of the primary collaboration and engagement tools allowing synchronous experiences, venue-to-venue
- 02. Content One Content One is recommended to ensure presentations are coordinated from a central location and distributed with minimum contact
- 03. Cloud Collaboration Tools Additional cloud collaboration tools, such as Zoom Rooms or Miro might be introduced to connect cloud breakout tracks and workshops
- 04. High Bandwidth Because each attendee will need their own connection to accomodate non-local breakout tracks, higher bandwidth is essential
- 05. Room Moderators To serve as point of contact and ensure rooms run synchronously with the entire event, Room Moderators are essential

ENHANCEMENTS

- Engage Meeting Package
- Comfortable seating
- Large format scenic such as Backdrop Pro
- Signage for wayfinder and traffic
- Digital signage
- Recording
- Transcription services
- Webcasting microsite

EVENT CREW

- Set/Strike team
- Cleaning team
- Operating team
- Webcasting team
- Project Manager
- Stage Manager
- Producer

4. CLEANING GUIDELINES

Equipment Considerations and Enhanced Cleaning Procedures

Meetings and events support more than ten million jobs worldwide. To help get the live event industry, event planners, and our teams back to work and begin the road to recovery following the COVID-19 pandemic, meeting safely will undoubtedly be a priority.

PSAV is committed to providing a safe and healthful workplace for all team members, customers and business partners, empowering our team members with enhanced cleaning procedures and support in alignment with our commitment to safety. Implementing standards surrounding items that our customer and team members frequently encounter will be at the forefront of these enhanced cleaning procedures. The balance of this document will highlight the PSAV cleaning procedures.

Audiovisual Equipment Disinfection Recommendations

In this section, you will find recommended practices and solutions for the cleaning and disinfection of specific types of audiovisual equipment.

HIGH TOUCH ITEMS CLEANED FOR YOUR SAFETY

- Lavalier Microphone
- Handheld MIC
- Head Set MIC
- Headphones
- Push to Talk MIC
- Polycomm Unit
- Radios and Other Comms Equipment
- Laptops/Computer
- Keyboard and Mouse
- Tablet
- Slide Advancer
- Wireless Presentation Accessories (i.e. Clickshare)
- Power Strip
- Cable
- Monitor
- Projectors and Cart
- Flip Chart Easel
- Flip Chart Markers
- Tech Table Equipment

MeetSAFE

Workplace and Equipment Cleaning SOP

PSAV remains committed to providing a safe and healthful workplace for all team members, customers, and business partners. With that, our team members will be required to follow the recommended guidelines with regard to general hygiene and disinfecting equipment between events. If your event should require a more enhanced cleaning solution, please reach out to your PSAV representative.

Meeting Space:

- Refresh (prior to event start) and strike:
 - Technician will use approved cleaners / disinfectants to clean all high-touch areas of PSAV equipment to include:
 - Mics
 - Remotes / Slide Advancers / Wireless Mice
 - Faders / Dimmers
 - Flipchart Easel / Markers
 - Radios
 - PSAV Music Devices
 - Laptops / iPads
 - Podium surface (PSAV-provided)
 - Headphones
 - Polycom Units
 - Power Strips
 - Technician will leave a cleaning verification card with their name, signature, and date / time the cleaning was completed (~1 hour prior to event start)

Dear PSAV Customer,

Our team values your safety as much as your overall event experience. We have carefully wiped down all high-touch points with alcohol wipes to limit the risk of spreading germs. We do this to protect you, our venue partners, and our team members. We are happy to do so.

Cleaned by: _____

Date/Time: _____

PSAV

- Technician will meet guest in room prior to doors, make introduction, test equipment and verify cleaning
- All team members will comply with local guidelines and work in coordination with local venue plans pertaining to PPE use and distancing

Office / Storage Space:

- Routine handwashing for at least 20 seconds with soap and water
 - Encourage cleaning of personal cell phones and personal tools on a routine/daily basis
 - Posters to be displayed for awareness and reminding team members:
 - International - WHO: <https://www.who.int/gpsc/5may/resources/posters/en/>
 - US - CDC: <https://www.cdc.gov/handwashing/pdf/HH-Posters-Eng-Restroom-508.pdf>
- Hand Sanitizer and approved chemicals should be available for team member use in both office and storage rooms
- Daily High-touch items should be regularly cleaned using approved cleaners / disinfectants – avoid cross-use where appropriate
 - Light controls/switches, doorknobs and drawer/cabinet handles
 - Hardline phones, house phones, MOD phones and radios
 - Computers mouse and keyboard
 - Tools (Truss wrench, measuring devices, pliers, lifts / ladders)
- When handling equipment and cases, contact points should be cleaned using appropriate cleaners / disinfectants to include pushing / lifting points and handles

PSAV®